

Data Sheet



Article number: 2314449501

Description: E+G rubber wheel 449501
RE.E2-080-RBL loose wheel

Measures

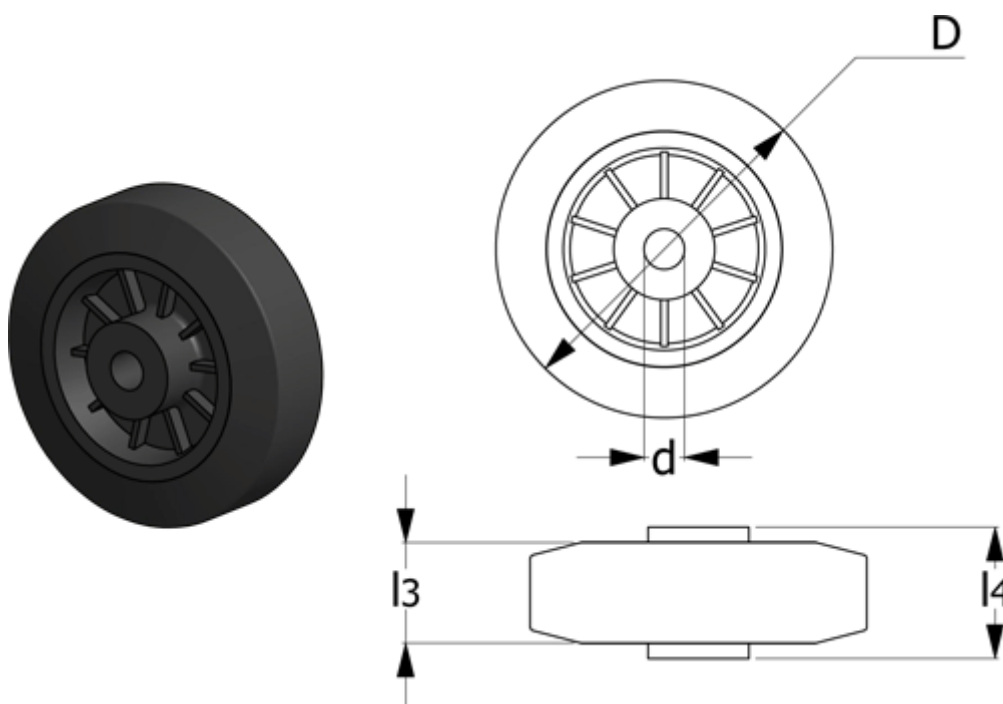

Code = 449501
d = 12
D = 80
Dynamic load (N) = 650
g = 110
l3 = 25
l4 = 39
Max static load (N) = 1500

Rolling resistance (N) = 500
Type = RE.E2-080-RBL